



Liberty 760-F

na zem | Bodenstehend | floor standing version

Indikace výkonu | Indikative Leistung | indicative output 75/65°C
137 Watt
(na článek | pro Gleid | per section)

Technický list | Technische Zeichnung | technical drawing

Všechny rozměry v [mm] | alle Abmessungen in [mm] | all dimensions in [mm]
L...délka radiátoru | L...Gesamtlänge | L...length of radiator

-  Jen topení, (uzavřený) topný systém (voda)
Nur Heizung, (geschlossenes) Heizsystem (Wasser)
Heating only, (closed) heating system (water)
-  Kombinovaný provoz | Topení + elektrický
Kombi-Betrieb | Wasser + Elektrisch
Combined system | Water + electric heating
-  Jen elektrický provoz (na dotaz)
Rein elektrisch (auf Anfrage)
Electric version only (on request)

Možnosti připojení | Anschlussmöglichkeiten | Connections



úhlopříčné
wechselseitig
diagonal



boční
einseitig
one side



boční spodní L/P
seitlich unten L/R
bottom on side L/R

Rošteče pro ventily | Ventilabstände | Distances for valves

Ventil | valve ArtDECO K=55mm, V=55mm

Ventil | valve Liberty K=55mm, V=55mm

Ventil | valve EPOCA K=60mm, V=45mm (+10 závit | Gewinde | winding)

Ventil | valve ANUOVA K=55mm, V=55mm

Ventil | valve Buckingham Major K=49mm, V=49mm

Tolerance | Toleranz | tolerance +/- 5mm

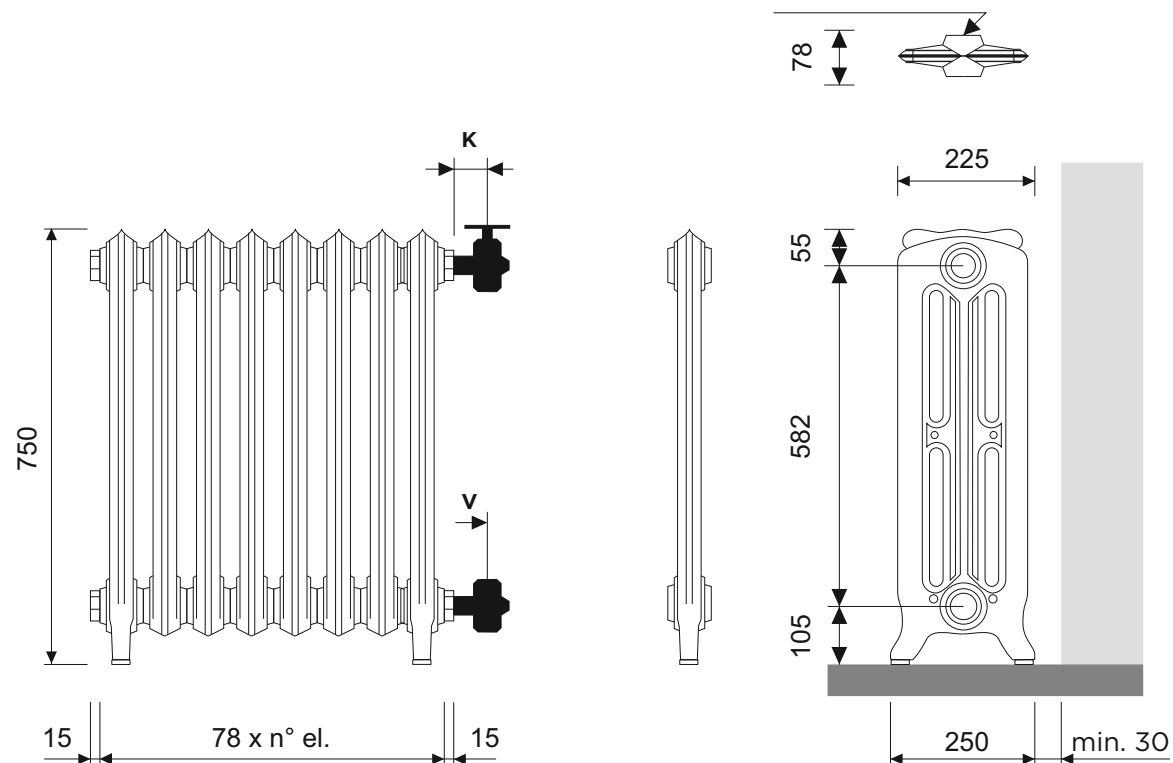

Tolerance délky | Längentoleranz | length tolerance +/- 1%



Litina | Gusseisen | Cast iron

šedá litina | Grauguss | grey cast iron
2 výšky | Höhen | heights



Parametry | Tech.Daten | data

max. 4 bar
max. 90° C



Povrch | Oberfläche | surface

RAL 7022 šedá | Umbragrau | umbra grey
+% ostatní | andere | other RAL

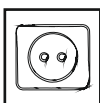

Elektrický | Elektrisch | el. version

~ 230V, 50Hz | max. 2000 Watt
na dotaz | auf Anfrage | on request

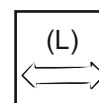

Délky | Längen | lengths

min. 3 max. 31 článků | Glieder | sections
po | nach | each 78 mm

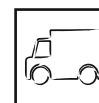

Dodání | Lieferung | Delivery

4-6 týdnů | Wochen | weeks
+2-4 projekty | für Projekte | for projects



Liberty 760-W

na stěnu | Wandvariante | wall mounted version

Indikace výkonu | Indikative Leistung | indicative output 75/65°C
137 Watt
(na článek | pro Gleid | per section)

Technický list | Technische Zeichnung | technical drawing

Všechny rozměry v [mm] | alle Abmessungen in [mm] | all dimensions in [mm]
L...délka radiátoru | L...Gesamtlänge | L...length of radiator

-  Jen topení, (uzavřený) topný systém (voda)
Nur Heizung, (geschlossenes) Heizsystem (Wasser)
Heating only, (closed) heating system (water)
-  Kombinovaný provoz | Topení + elektrický
Kombi-Betrieb | Wasser + Elektrisch
Combined system | Water + electric heating
-  Jen elektrický provoz (na dotaz)
Rein elektrisch (auf Anfrage)
Electric version only (on request)

Možnosti připojení | Anschlussmöglichkeiten | Connections



úhlopříčné
wechselseitig
diagonal



boční
einseitig
one side



boční spodní L/P
seitlich unten L/R
bottom on side L/R

Rošteče pro ventily | Ventilabstände | Distances for valves

Ventil | valve ArtDECO K=55mm, V=55mm
Ventil | valve Liberty K=55mm, V=55mm
Ventil | valve EPOCA K=60mm, V=45mm (+10 závit | Gewinde | winding)
Ventil | valve ANUOVA K=55mm, V=55mm
Ventil | valve Buckingham Major K=49mm, V=49mm

Tolerance | Toleranz | tolerance +/- 5mm

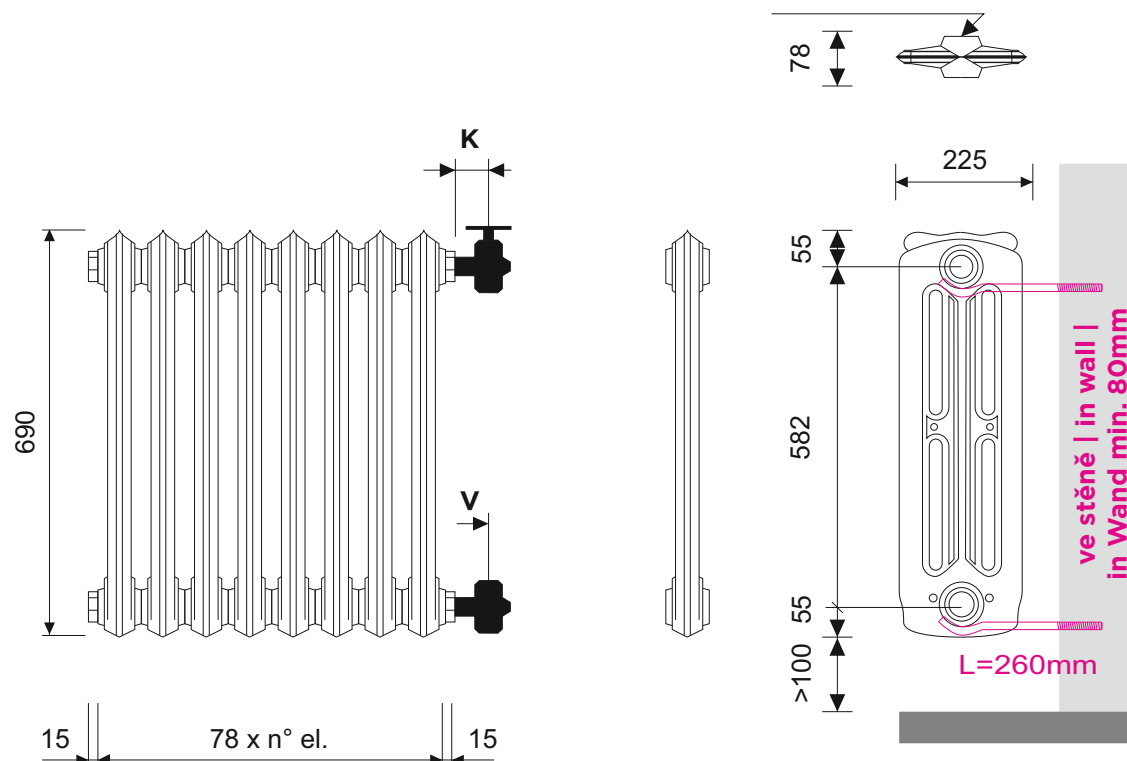

Tolerance délky | Längtolerenz | length tolerance +/- 1%



Litina | Gusseisen | Cast iron

šedá litina | Grauguss | grey cast iron
2 výšky | Höhen | heights



Parametry | Tech.Daten | data

max. 4 bar
max. 90° C



Povrch | Oberfläche | surface

RAL 7022 šedá | Umbragrau | umbra grey
+% ostatní | andere | other RAL

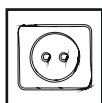

Elektrický | Elektrisch | el. version

~ 230V, 50Hz | max. 2000 Watt
na dotaz | auf Anfrage | on request

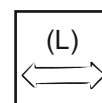

Délky | Längen | lengths

min. 3 max. 30 článků | Glieder | sections
po | nach | each 78 mm

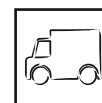

Dodání | Lieferung | Delivery

4-6 týdnů | Wochen | weeks
+2-4 projekty | für Projekte | for projects



Liberty 950-F

na zem | Bodenstehend | floor standing version

**Indikace výkonu | Indikative Leistung | indicative output 75/65°C
182 Watt
(na článek | pro Gleid | per section)**

Technický list | Technische Zeichnung | technical drawing

Všechny rozměry v [mm] | alle Abmessungen in [mm] | all dimensions in [mm]
L...délka radiátoru | L...Gesamtlänge | L...length of radiator

-  Jen topení, (uzavřený) topný systém (voda)
Nur Heizung, (geschlossenes) Heizsystem (Wasser)
Heating only, (closed) heating system (water)
-  Kombinovaný provoz | Topení + elektrický
Kombi-Betrieb | Wasser + Elektrisch
Combined system | Water + electric heating
-  Jen elektrický provoz (na dotaz)
Rein elektrisch (auf Anfrage)
Electric version only (on request)

Možnosti připojení | Anschlussmöglichkeiten | Connections



úhlopříčné
wechselseitig
diagonal



boční
einseitig
one side



boční spodní L/P
seitlich unten L/R
bottom on side L/R

Rošteče pro ventily | Ventilabstände | Distances for valves

Ventil | valve ArtDECO K=55mm, V=55mm
Ventil | valve Liberty K=55mm, V=55mm
Ventil | valve EPOCA K=60mm, V=45mm (+10 závit | Gewinde | winding)
Ventil | valve ANUOVA K=55mm, V=55mm
Ventil | valve Buckingham Major K=49mm, V=49mm

Tolerance | Toleranz | tolerance +/- 5mm

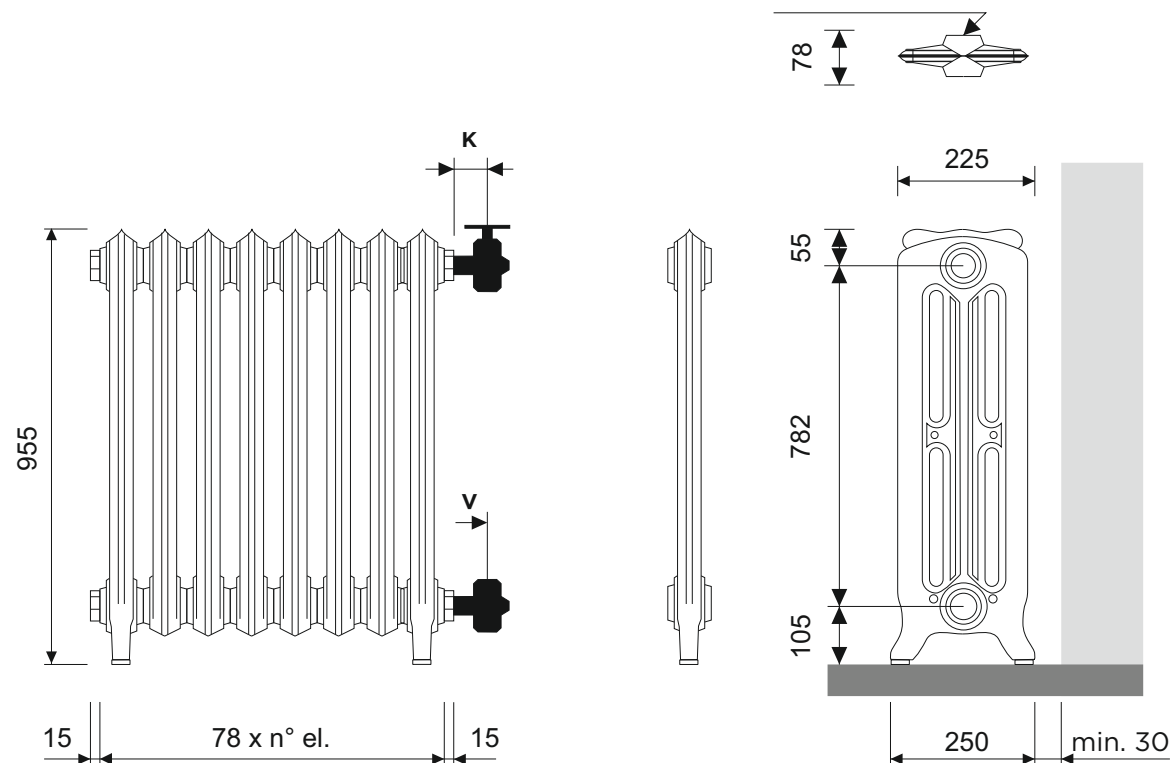

Tolerance délky | Längentoleranz | length tolerance +/- 1%



Litina | Gusseisen | Cast iron

šedá litina | Grauguss | grey cast iron
2 výšky | Höhen | heights



Parametry | Tech.Daten | data

max. 4 bar
max. 90° C



Povrch | Oberfläche | surface

RAL 7022 šedá | Umbragrau | umbra grey
+% ostatní | andere | other RAL

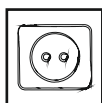

Elektrický | Elektrisch | el. version

~ 230V, 50Hz | max. 2000 Watt
na dotaz | auf Anfrage | on request

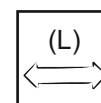

Délky | Längen | lengths

min. 3 max. 31 článků | Glieder | sections
po | nach | each 78 mm

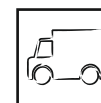

Dodání | Lieferung | Delivery

4-6 týdnů | Wochen | weeks
+2-4 projekty | für Projekte | for projects



Liberty 960-W

na stěnu | Wandvariante | wall mounted version

Indikace výkonu | Indikative Leistung | indicative output 75/65°C
182 Watt
(na článek | pro Gleid | per section)

Technický list | Technische Zeichnung | technical drawing

Všechny rozměry v [mm] | alle Abmessungen in [mm] | all dimensions in [mm]
L...délka radiátoru | L...Gesamtlänge | L...length of radiator

-  Jen topení, (uzavřený) topný systém (voda)
Nur Heizung, (geschlossenes) Heizsystem (Wasser)
Heating only, (closed) heating system (water)
-  Kombinovaný provoz | Topení + elektrický
Kombi-Betrieb | Wasser + Elektrisch
Combined system | Water + electric heating
-  Jen elektrický provoz (na dotaz)
Rein elektrisch (auf Anfrage)
Electric version only (on request)

Možnosti připojení | Anschlussmöglichkeiten | Connections



úhlopříčné
wechselseitig
diagonal



boční
einseitig
one side



boční spodní L/P
seitlich unten L/R
bottom on side L/R

Rošteče pro ventily | Ventilabstände | Distances for valves

Ventil | valve ArtDECO K=55mm, V=55mm
Ventil | valve Liberty K=55mm, V=55mm
Ventil | valve EPOCA K=60mm, V=45mm (+10 závit | Gewinde | winding)
Ventil | valve ANUOVA K=55mm, V=55mm
Ventil | valve Buckingham Major K=49mm, V=49mm

Tolerance | Toleranz | tolerance +/- 5mm

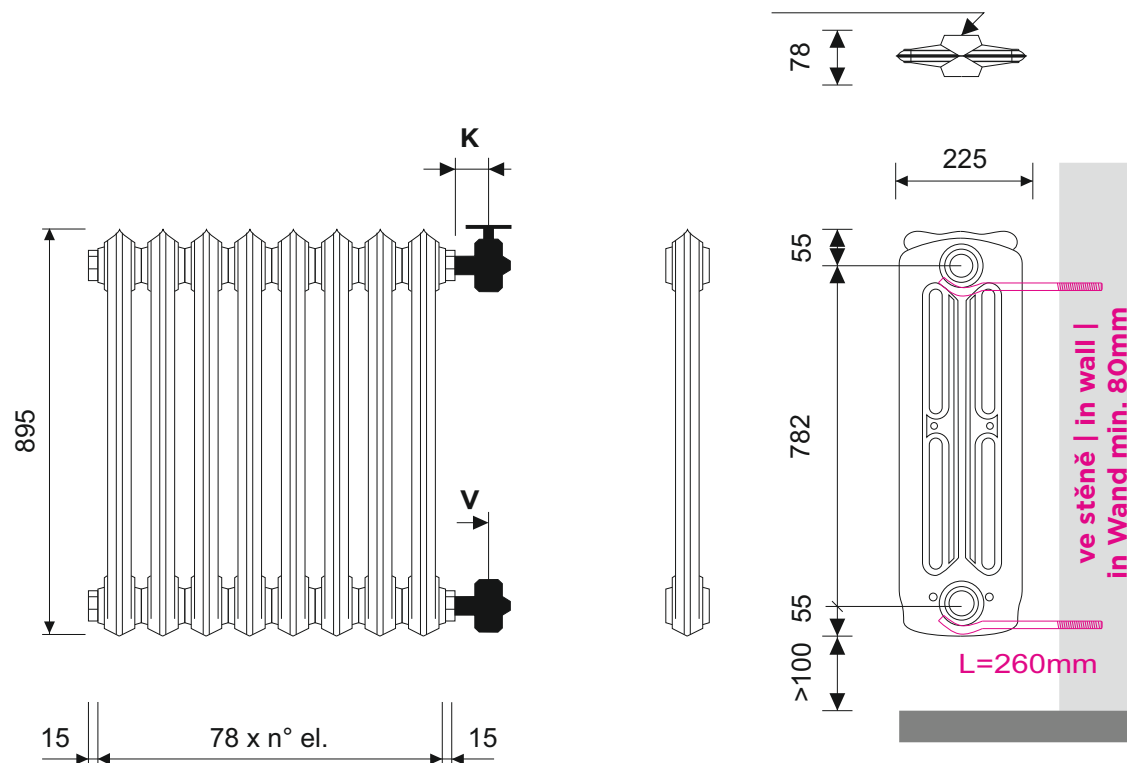

Tolerance délky | Längentoleranz | length tolerance +/- 1%



Litina | Gusseisen | Cast iron

šedá litina | Grauguss | grey cast iron
2 výšky | Höhen | heights



Parametry | Tech.Daten | data

max. 4 bar
max. 90° C

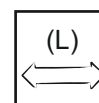

Délky | Längen | lengths

min. 3 max. 30 článků | Glieder | sections
po | nach | each 78 mm



Povrch | Oberfläche | surface

RAL 7022 šedá | Umbragrau | umbra grey
+% ostatní | andere | other RAL

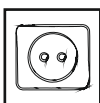

Elektrický | Elektrisch | el. version

~ 230V, 50Hz | max. 2000 Watt
na dotaz | auf Anfrage | on request

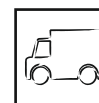

Dodání | Lieferung | Delivery

4-6 týdnů | Wochen | weeks
+2-4 projekty | für Projekte | for projects